

Conditioned Crawl Space Construction, Performance and Codes

Research Report - 0401

2004-11-02 by Joseph Lstiburek, Building Science Corporation

Abstract:

Conditioned crawl spaces perform better than vented crawl spaces in terms of safety, health, comfort, durability and energy consumption. Conditioned crawl spaces also do not cost more to construct than vented crawl spaces. Existing vented crawl spaces are experiencing serious moisture and mold problems and are costing builders and homeowners significant resources to repair. Despite the obvious problems with existing vented crawl spaces and the obvious benefits of conditioned crawl spaces there is not a significant trend towards the construction of conditioned crawlspaces. One of the reasons typically cited by builders and designers is “the code does not allow me to build unvented crawl spaces”. This is both generally correct and misleading. The model codes do not allow the construction of “unvented” crawl spaces – except in very limited circumstances, but they do allow the construction of “conditioned” crawl spaces. The distinction is important and necessary. Four conditioned crawl spaces were constructed and monitored over a 12-month period. The data is presented and used to support the current code requirements for the construction of conditioned crawl spaces.



BUILDING AMERICA

SYSTEMS ENGINEERING APPROACH TO DEVELOPMENT OF ADVANCED RESIDENTIAL BUILDINGS

5.C.2.4 CONDITIONED CRAWL SPACE CONSTRUCTION, PERFORMANCE AND CODES

RE: TASK ORDER NO. KAAX-3-32443-4, 5, AND 6
UNDER
TASK ORDERING AGREEMENT NO. KAR-8-18412-00

MIDWEST RESEARCH INSTITUTE,
NATIONAL RENEWABLE ENERGY LABORATORY DIVISION,
1617 COLE BOULEVARD,
GOLDEN, CO
80401-3393

BUILDING SCIENCE CONSORTIUM
CONSORTIUM LEADER:

BUILDING SCIENCE CORPORATION
70 MAIN STREET, WESTFORD, MA
(978) 589-5100
CONTACT: BETSY PETTIT, AIA

CONSORTIUM MEMBERS:
PULTE/DEL WEBB CORPORATION
DAVID WEEKLEY HOMES
ARTISTIC HOMES
CENTEX HOMES
TECHNICAL OLYMPIC
APRIL-AIRE, INC.
CARRIER
GREENFIBER
DOW CHEMICAL COMPANY
MASCO
CERTAINTEED
FORTIFIBER

NOVEMBER 2, 2004

Conditioned Crawlspace Construction, Performance and Codes

Table of Contents

Abstract	2
Background	2
Constructing Conditioned Crawl Spaces	2
Conditioned Crawl Space Performance	9
Code Language	15
2003 International Mechanical Code	15
2003 International Building Code	15
2004 Supplement to the IECC	16
2004 Supplement To The IRC	16
2003 International Residential Code	17

Abstract

Conditioned crawl spaces perform better than vented crawl spaces in terms of safety, health, comfort, durability and energy consumption. Conditioned crawl spaces also do not cost more to construct than vented crawl spaces. Existing vented crawl spaces are experiencing serious moisture and mold problems and are costing builder's and homeowners significant resources to repair. Despite the obvious problems with existing vented crawl spaces and the obvious benefits of conditioned crawl spaces there is not a significant trend towards the construction of conditioned crawlspaces. One of the reasons typically cited by builders and designers is "the code does not allow me to build unvented crawl spaces". This is both generally correct and misleading. The model codes do not allow the construction of "unvented" crawl spaces – except in very limited circumstances, but they do allow the construction of "conditioned" crawl spaces. The distinction is important and necessary. Four conditioned crawl spaces were constructed and monitored over a 12 month period. The data is presented and used to support the current code requirements for the construction of conditioned crawl spaces.

Background

Crawl space venting is generally viewed as good practice despite the obvious moisture problems that occur when outside air with a dew point higher than interior crawl space surface temperature is permitted to enter a crawl space. Unvented, conditioned crawl spaces with insulation on the perimeter solve this problem. Unvented, conditioned crawl spaces with insulation on the perimeter perform better in terms of safety and health (pest control), comfort (warm floors, uniform temperatures), durability (moisture) and energy consumption than passively vented crawl spaces with sub floor insulation.

Perimeter insulation rather than floor insulation performs better in all climates from an energy conservation perspective. The crawl space temperatures, dew points and relative humidities track that of the house. Crawl spaces insulated on the perimeter are warmer and drier than crawl spaces insulated between the crawl space and the house. Cold surfaces that can condense water are minimized when crawl spaces are conditioned.

Wintertime ventilation makes crawl spaces colder and increases the heat loss from the home – venting crawl spaces wastes energy, and can lead to freezing pipes and uncomfortable floors.

Crawl spaces should be designed and constructed as mini-basements, part of the house – within the conditioned space. They should be insulated on their perimeters and should have a continuous sealed ground cover such as taped polyethylene. They should have perimeter drainage just like a basement when the crawl space ground level is below the ground level of the surrounding grade.

Constructing Conditioned Crawl Spaces

Crawl spaces should be designed and constructed to be dry. A dry crawl space is less likely to have pests and termites and mold. A dry crawl space is therefore safer and healthier than a wet crawl space. Crawl spaces must control rainwater, groundwater and provide drainage for potential plumbing leaks or flooding incidents (Figure 1).

Crawl spaces must always have a drying mechanism. One of the most effective ways to provide a drying mechanism to a crawl space is to condition a crawl space by heating and cooling the crawl space as if the crawl space is included as part of the home. Air must be supplied to the crawl space from the home in order to provide this conditioning. This air can be returned back to the home or it can be exhausted (Figure 2, Figure 3, Figure 4 and Figure 5). Crawl spaces can also be included as part of the home (conditioning them) by connecting them to conditioned basements (Figure 6 and Figure 7).

Crawl spaces must always have a ground cover that prevents evaporation of ground moisture into the crawl space. There are many ways to provide a durable ground cover or liner. The option used depends on the resources available, the frequency of people entering the crawl space to either store possessions or to maintain equipment. One of the

most effective is 6 mil sheet polyethylene that has taped/sealed joints and that is attached to the crawl space perimeter walls. This ground cover must be continuous through piers and supports (Figure 8).

Crawl space perimeter walls should also be insulated. The perimeter walls can be insulated either internally or externally (Figure 9, Figure 10 and Figure 11). When insulating crawl spaces internally (as well as basements) it is important to not leave concrete or masonry exposed in order to control condensation – this is particularly important at perimeter foundation wall “steps” or changes in height (Figure 12). It is similarly necessary to control condensation at rim joist areas. This is best done using rigid insulation installed either externally to the rim joist or internally against the rim joist.

Air permeable insulation such as fiberglass batts, fiberglass blankets or spray applied cellulose should be avoided when insulating crawl space perimeters and rim joist assemblies. The air permeance characteristics of these types of insulations do not prevent moisture laden air from accessing surfaces that may be cold enough to condense water.

Where radon gas is a concern, a soil gas ventilation system can be installed under the ground cover (Figure 13).

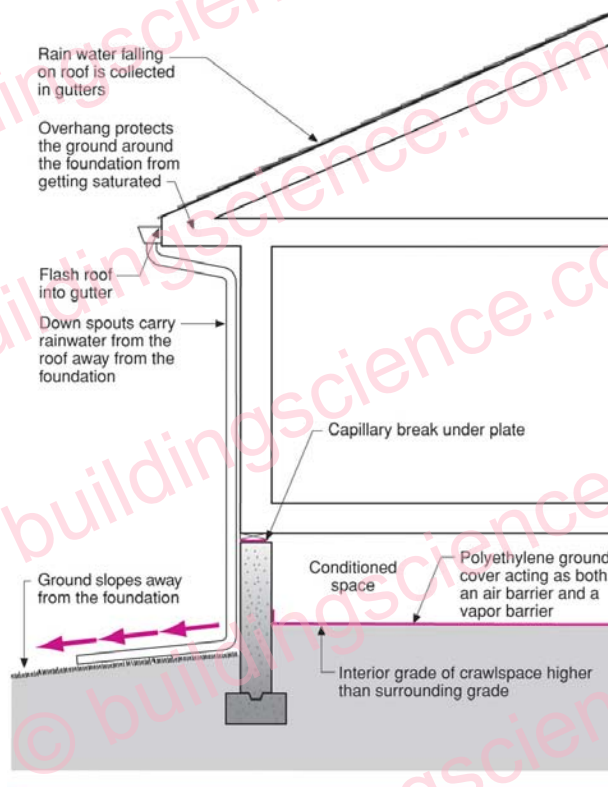
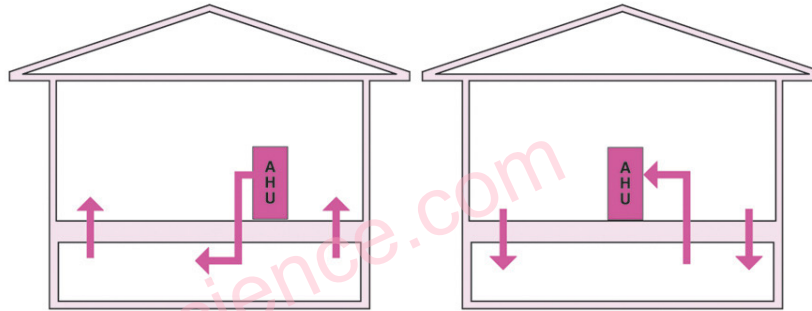

Figure 1
Groundwater Control with Crawlspace

- Keep rain water away from the foundation perimeter
- If the interior crawlspace is lower than the exterior grade, a sub-grade perimeter footing drain is necessary as in a basement foundation
- The crawlspace in this configuration is conditioned space; it is part of the "interior" of the building and should be heated, cooled and ventilated as part of the building's heating, cooling and ventilating strategy



A: Supply air to crawlspace

- Minimum 2-4"x8" transfer grilles **to** house
- 20 cfm of flow per 1,000ft² of crawlspace
- Air handler cycled at 5 minutes per hour

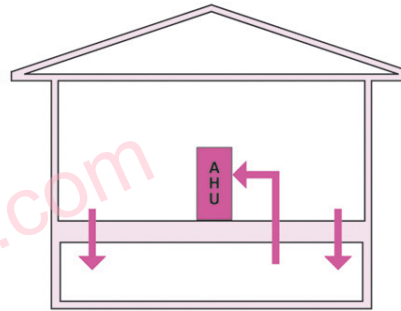

C: Return air from crawlspace

- Minimum 2-4"x8" transfer grilles **from** house
- 20 cfm of flow per 1,000ft² of crawlspace
- Air handler cycled at 5 minutes per hour

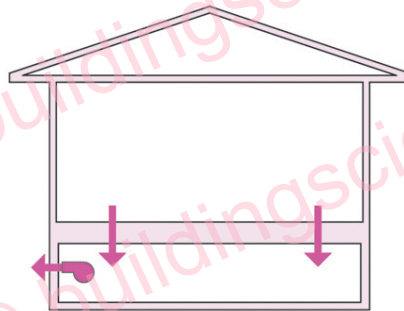

B: Exhaust fan in crawlspace

- Transfer air **from** house
- 20 cfm of flow per 1,000ft² of crawlspace
- Fan sized at ASHRAE 62.2 whole house flow rates:
7.5 cfm/person + 0.01 cfm/ft² of conditioned area
- For a 2,000ft² 3 bedroom house with 4 occupants:
4 x 7.5 cfm = 30 cfm
2,000ft² x 0.01 cfm = 20 cfm
30 cfm + 20 cfm = 50 cfm (i.e. 50 cfm exhaust fan)
- Fan runs continuously

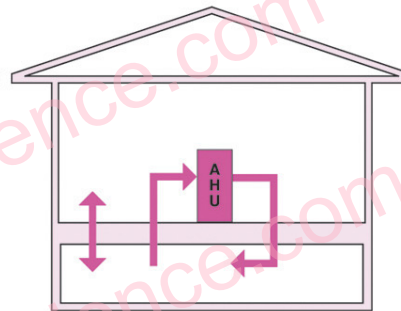

D: Supply and return to crawlspace

- Minimum 2-4"x8" transfer grilles **from** house through floor to equalize air pressure
- 20 cfm of flow per 1,000ft² of crawlspace
- Air handler cycled at 5 minutes per hour

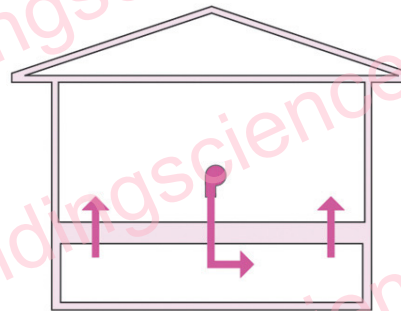

E: Supply air to crawlspace

- Minimum 2-4"x8" transfer grilles **to** house
- 20 cfm of flow per 1,000ft² of crawlspace

Figure 2
Conditioning Crawlspaces

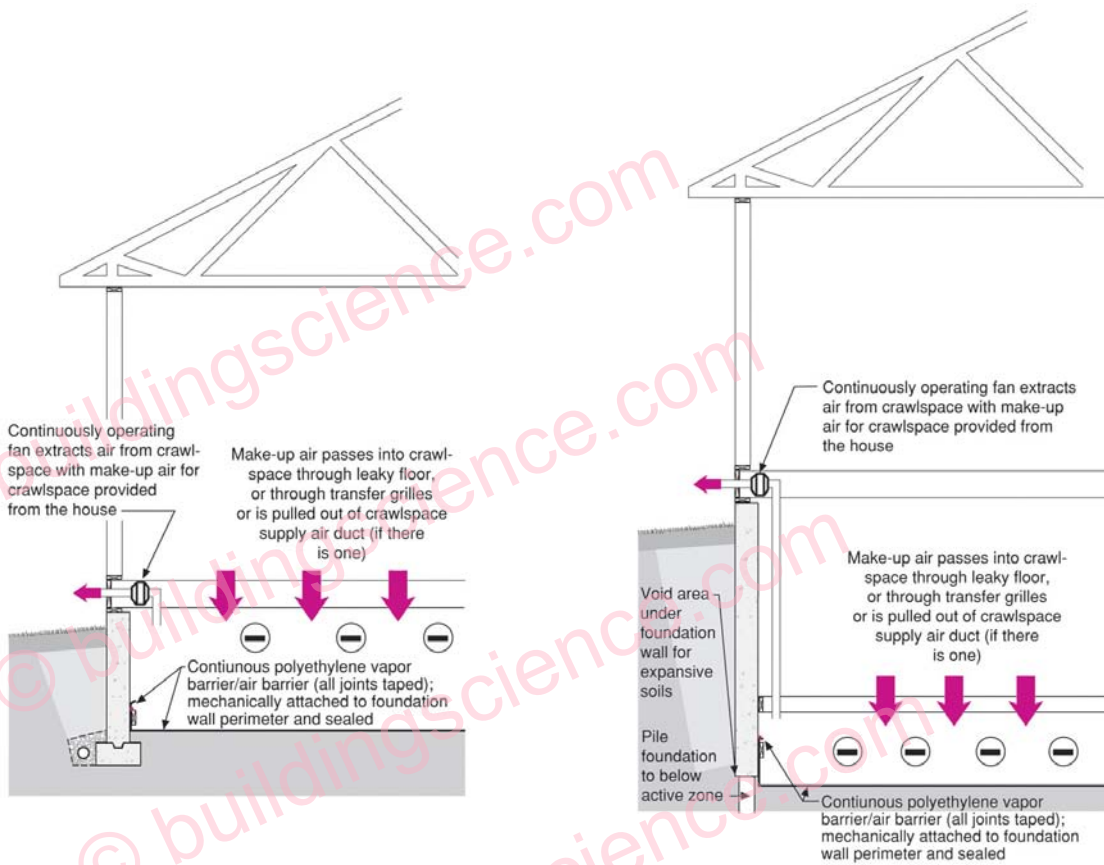

Figure 3
Controlled Mechanical Ventilation, Soil Gas and Crawlspace Ventilation System

- Crawlspace is conditioned (heated during the winter, cooled during the summer) either by make-up air pulled from the house or by a supply HVAC system duct
- Depressurization of crawlspace is facilitated by continuous exhaust from the crawlspace with make-up air for the crawlspace provided from the house common area
- Crawlspace ground cover is tighter than subfloor
- Crawlspace ventilation and house ventilation is provided by a single fan

Figure 4
Combined Controlled Ventilation, Soil Gas and Crawlspace Ventilation System

- Crawlspace is conditioned (heated during the winter, cooled during the summer) either by make-up air pulled from the house or by a supply HVAC system duct
- In regions with expansive soils and suspended wood basement floors over crawlspaces, depressurization of crawlspace can be facilitated by continuous exhaust from the crawlspace with make-up air for the crawlspace provided from the house common area
- Crawlspace ground cover is tighter than subfloor
- Crawlspace ventilation and house ventilation is provided by a single fan

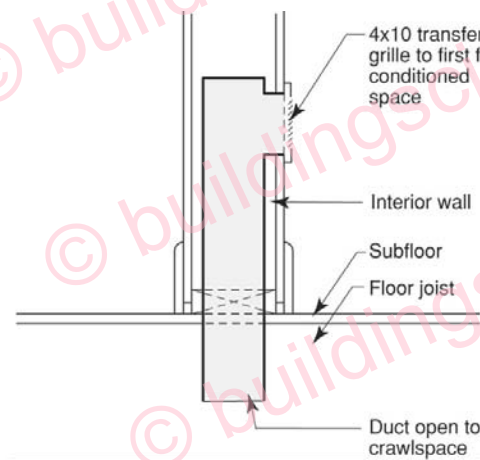

Figure 5
Transfer Grille to Crawlspace

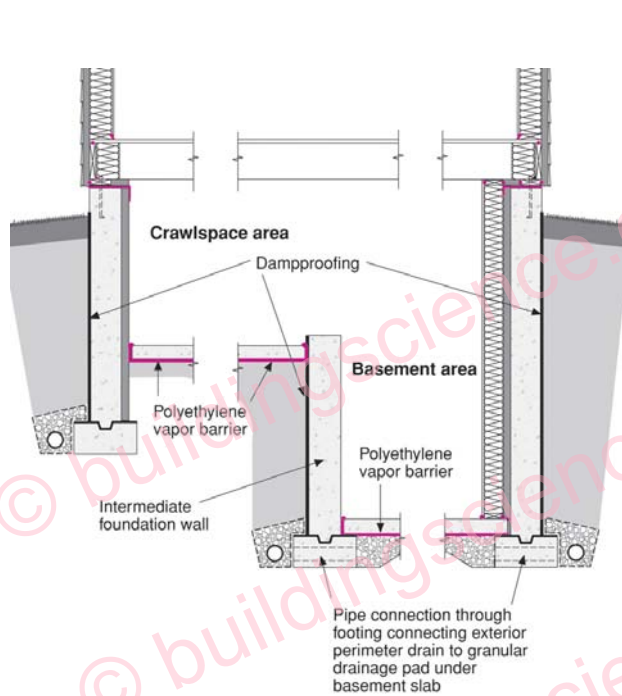

Figure 6
Connecting Crawlspace and Basement

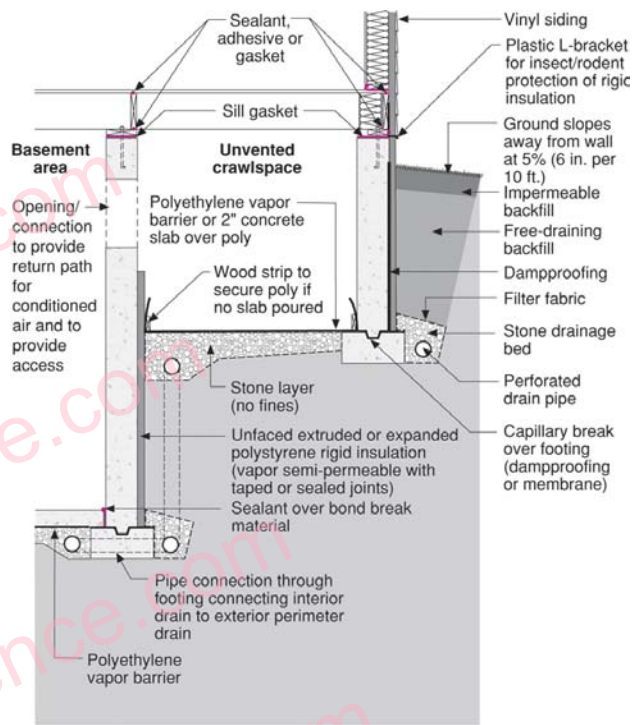

Figure 7
Connecting Crawlspace and Basement

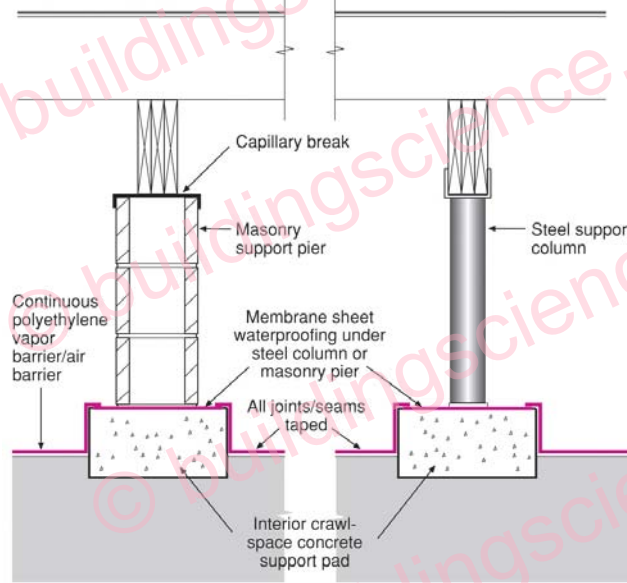

Figure 8
Air Barrier Continuity at Piers

- All joints and seams in polyethylene are taped
- Polyethylene ground cover taped to membrane sheet waterproofing at columns and piers

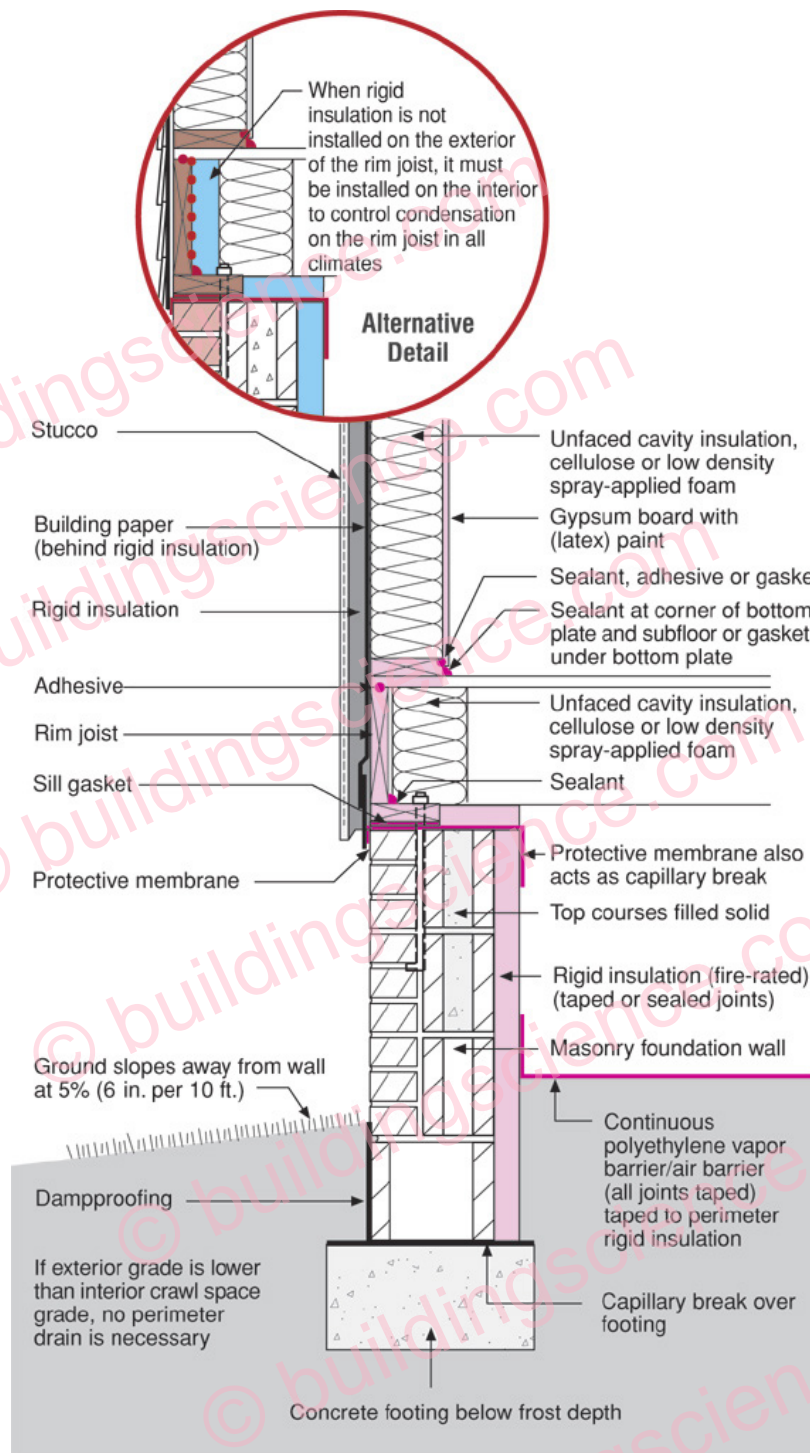

Figure 9
Internally Insulated Concrete Crawlspace with Stucco Wall Above

- Masonry wall can dry to exterior
- Protective membrane acts as termite barrier
- Rigid insulation must be fire-rated if it is left exposed on the interior
- Building paper installed shingle fashion acts as drainage plane located behind rigid insulation

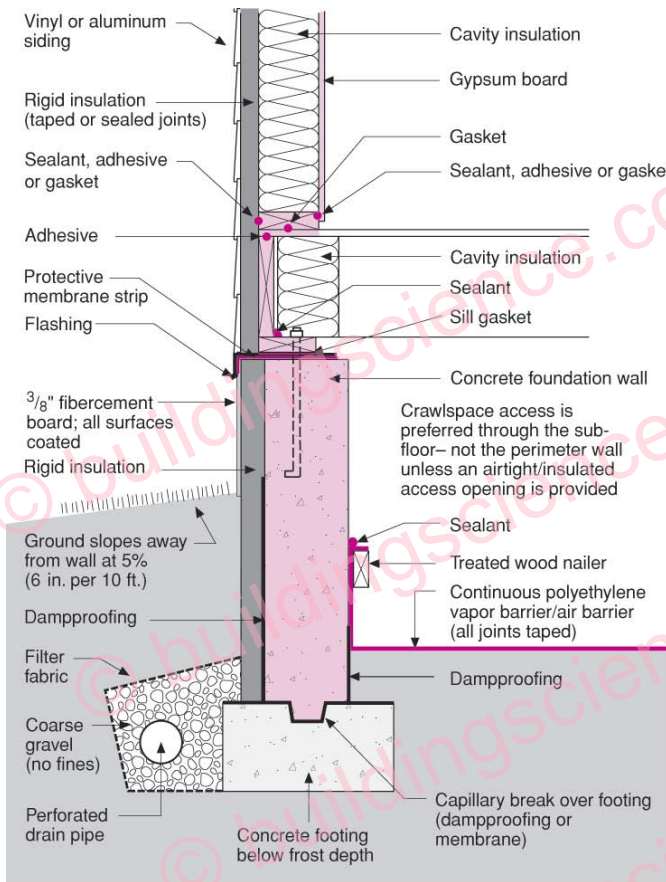

Figure 10
Externally Insulated Concrete Crawspace with Vinyl or Aluminum Siding Above

- Concrete wall warm, can dry to the interior; extremely low likelihood of mold
- Protective membrane acts as termite barrier
- Perimeter drain is necessary since interior grade is lower than exterior grade
- Protective membrane can be adhesive-backed roll roofing, below grade sheet waterproofing or an ice-dam protection membrane

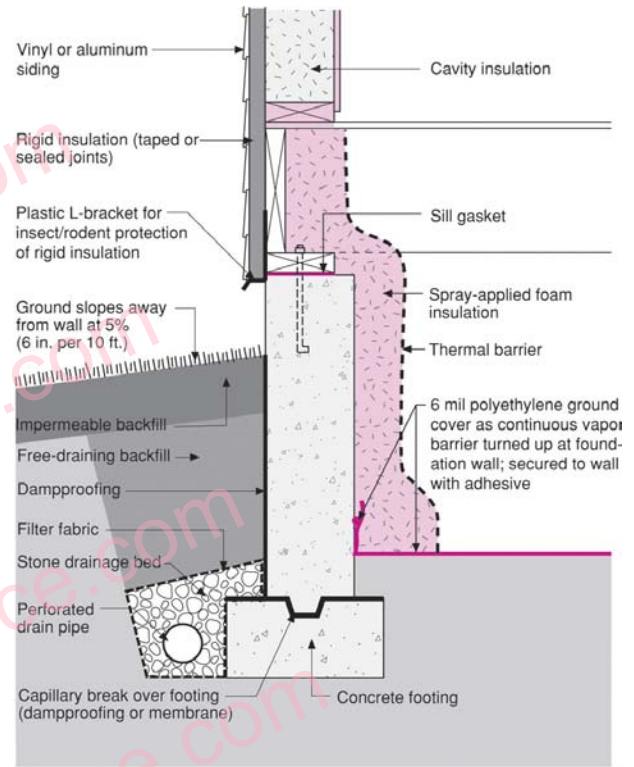

Figure 11
Internally Insulated Concrete Crawspace with Spray Foam

- A thermal barrier must be installed over spray foam insulations in crawlspaces

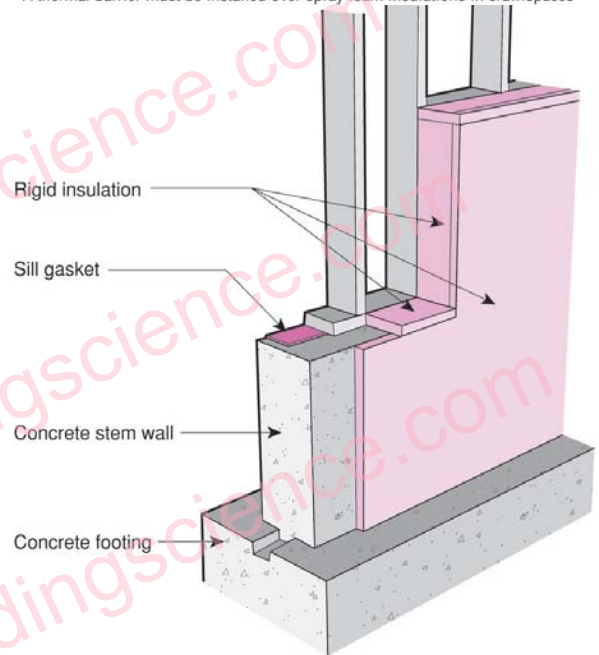

Figure 12
Step Down Foundation Wall

- In basement assemblies and conditioned crawspace assemblies that are internally insulated, it is important that rigid insulation "wraps" around exposed concrete/block assemblies at "step downs" in order to control condensation, particularly during summer months

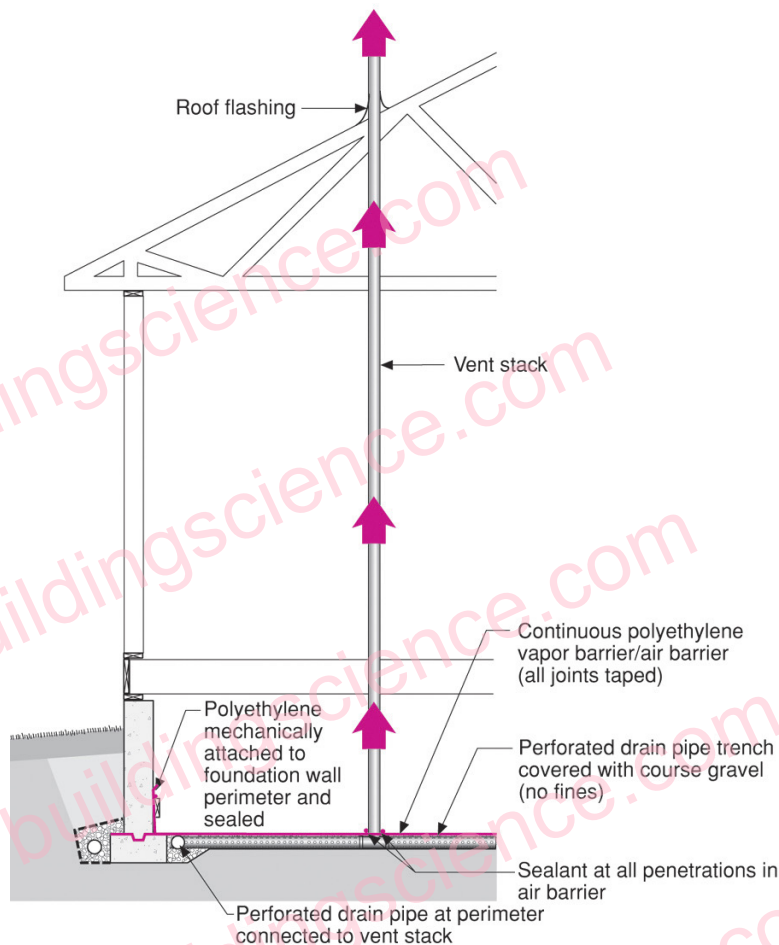

Figure 13
Soil Gas Ventilation System — Crawlspace Construction

- Perforated drain pipe in trenches covered with coarse gravel create depressurized zones under air barrier due to active fan located in attic or by passive stack action of warm vent stack located inside heated space
- Crawlspace is conditioned (heated during the winter, cooled during the summer) by a supply HVAC system duct
- Perforated drain pipe may not be necessary with tightly sealed polyethylene and coarse gravel
- Perimeter trench connected to centrally located vent stack

Conditioned Crawl Space Performance

Three conditioned crawl spaces were constructed in Ohio (one in Cleveland, two in Columbus) and one conditioned crawl space was constructed in Albuquerque, New Mexico. The crawl spaces were monitored over a twelve-month period.

The Cleveland House plots of indoor, outdoor and crawl space temperature are presented in Graph 1. Note how closely the crawl space temperature tracks the indoor temperature. The Cleveland House has an active supply duct providing conditioned air to the crawl space. Transfer grilles provide a return path to the indoor space above the crawl space.

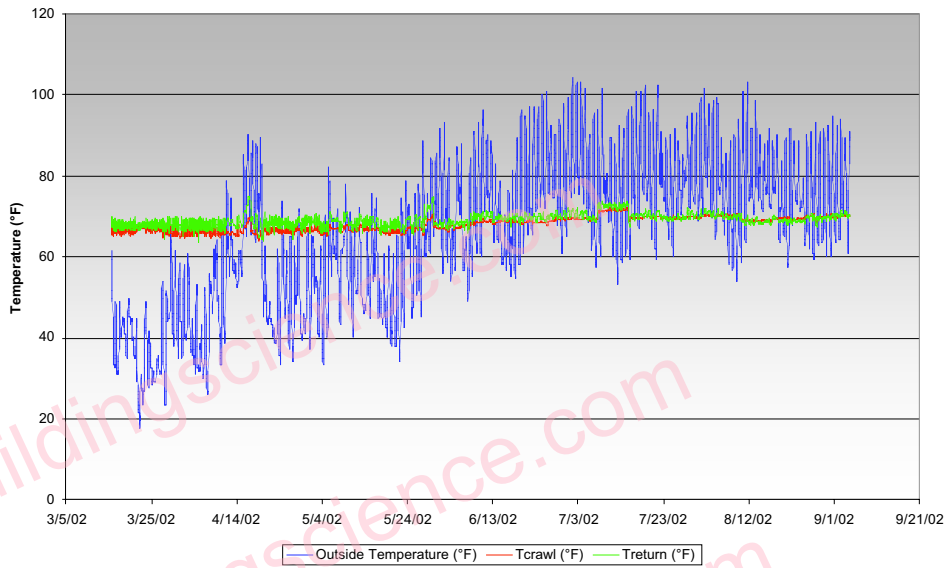

Graph 1: Cleveland House Indoor, Outdoor, and Crawlspace Temperatures

The Cleveland House plots of indoor, outdoor and crawl space dew point temperature are presented in Graph 2. Again note how closely the crawl space dew point tracks the indoor dew point.

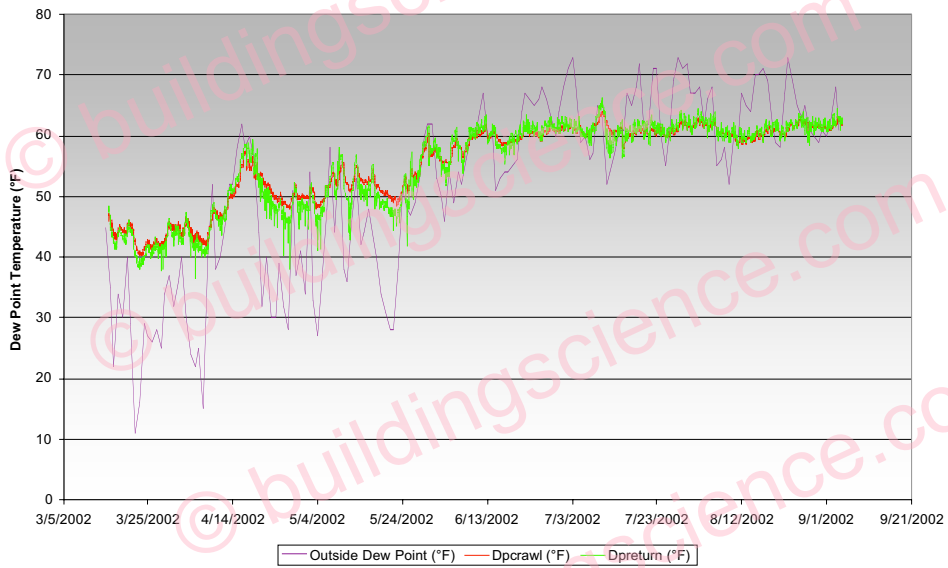

Graph 2: Cleveland House Indoor, Outdoor, and Crawlspace Dew Point Temperatures

The Cleveland House plots of indoor relative humidity and crawl space relative humidity are presented in Graph 3. The crawl space relative humidity again closely tracks the indoor relative humidity.

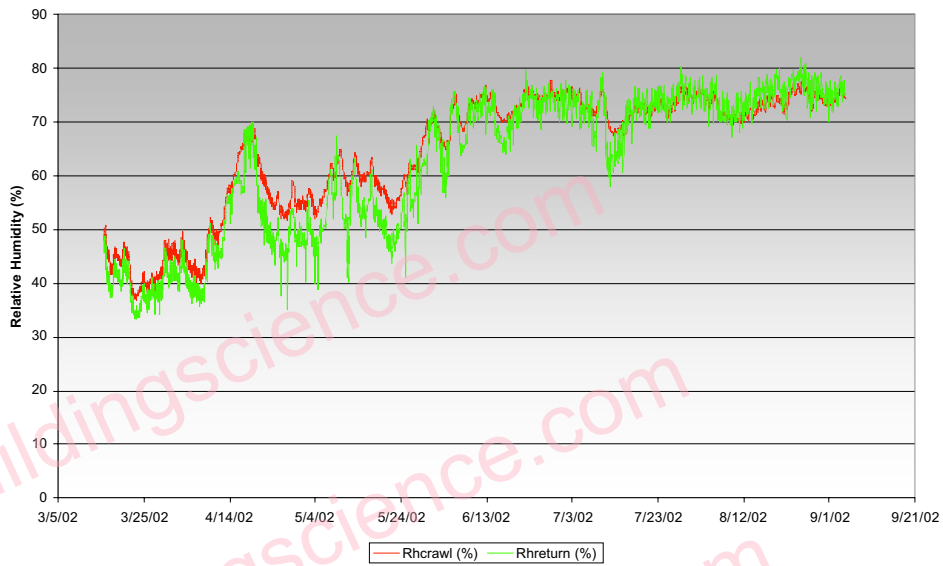

Graph 3: Cleveland House Indoor and Crawlspace Relative Humidity

The Gates House (Columbus) plots of indoor, outdoor and crawl space temperature are presented in Graph 4. In this home, the crawl space is somewhat cooler than the indoor temperature by 5 to 10 degrees. The Gates house crawl space is “passively” connected to the interior with transfer grilles only (no supply duct was provided to the crawl space).

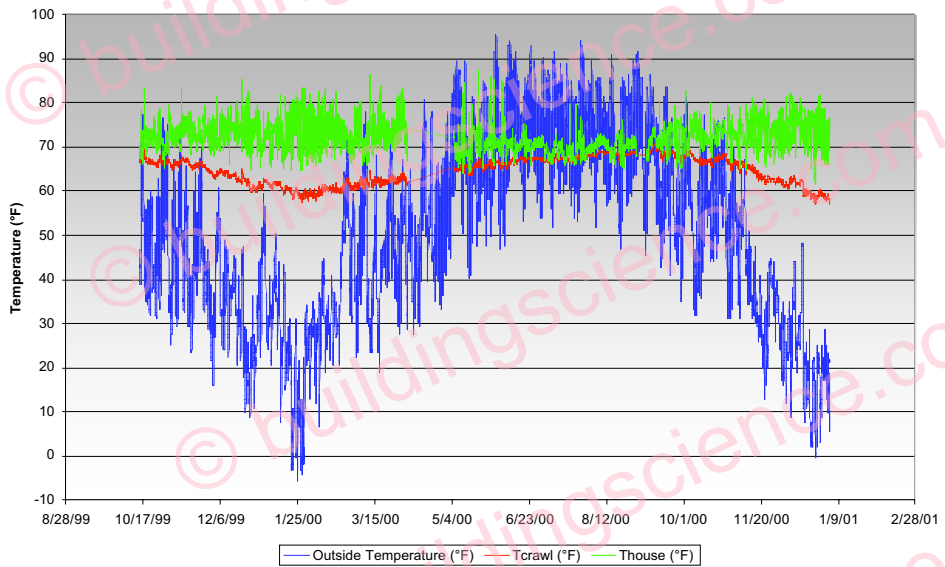

Graph 4: Gates House (Columbus) Indoor, Outdoor, and Crawlspace Temperatures

The Gates House (Columbus) plots of indoor, outdoor and crawl space dew point temperature are presented in Graph 5. The crawl space dew point is consistently higher than the indoor dew point. Again, however, the crawl space dew point does track the indoor dew point.

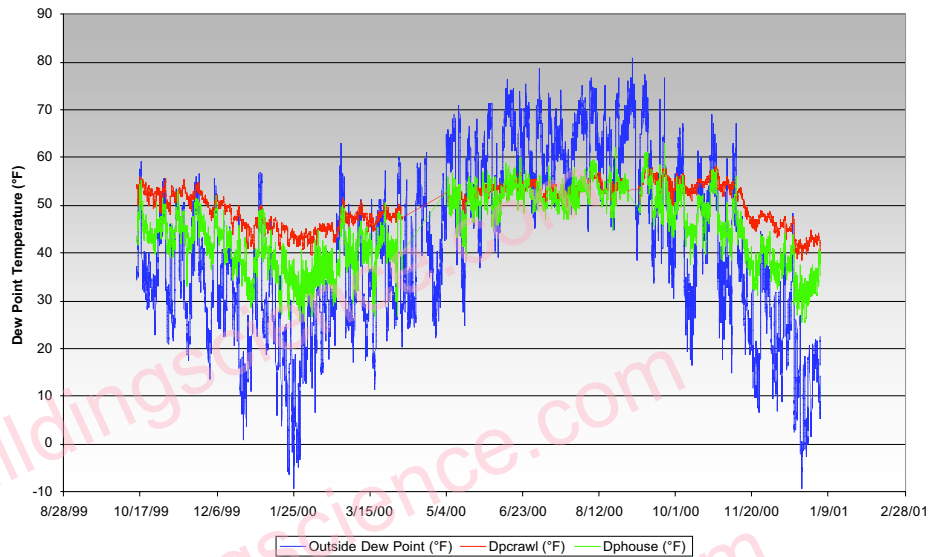

Graph 5: Gates House (Columbus) Indoor, Outdoor, and Crawlspace Dew Point Temperatures

The Gates House (Columbus) plots of indoor relative humidity and crawl space relative humidity are presented in Graph 6. The crawl space relative humidity is consistently higher than the house relative humidity – as would be expected from the previous temperature plots and dew point plots.

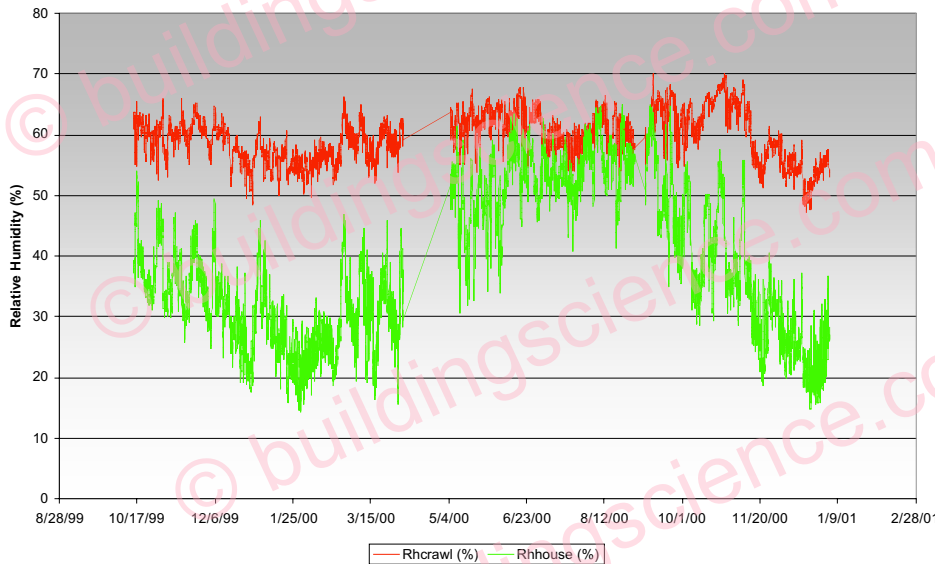

Graph 6: Gates House (Columbus) Indoor and Crawlspace Relative Humidity

The Meeder House (Columbus) plots of indoor, outdoor and crawl space temperature are presented in Graph 7. The crawl space temperature closely tracks the indoor temperature. Like the Cleveland House, the Meeder House has an active supply duct providing conditioned air to the crawl space and transfer grilles providing a return path to the indoor space above the crawl space.

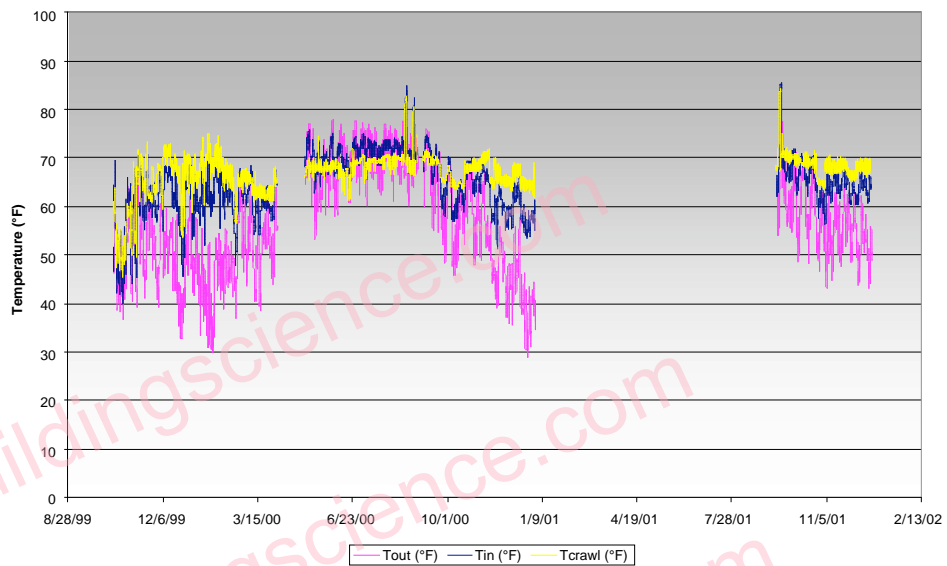

Graph 7: Meeder House (Columbus) Indoor, Outdoor, and Crawlspace Temperatures

The Meeder House (Columbus) plots of indoor, outdoor and crawl space dew point temperature are presented in Graph 8. Again note how closely the crawl space dew point tracks the indoor dew point.

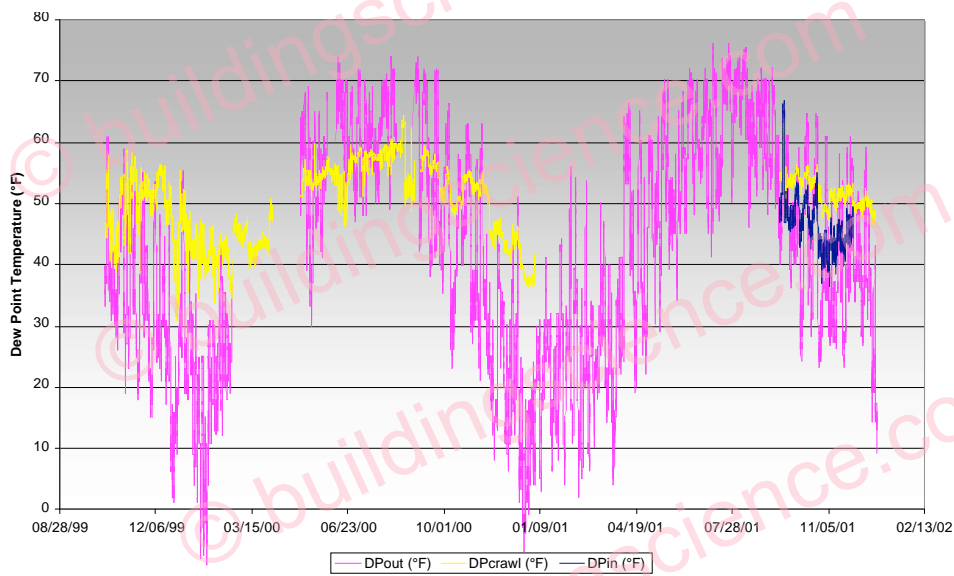

Graph 8: Meeder House (Columbus) Indoor, Outdoor, and Crawlspace Dew Point Temperatures

The Meeder House (Columbus) plots of indoor relative humidity and crawl space relative humidity are presented in Graph 9. The crawl space relative humidity again tracks the indoor relative humidity.

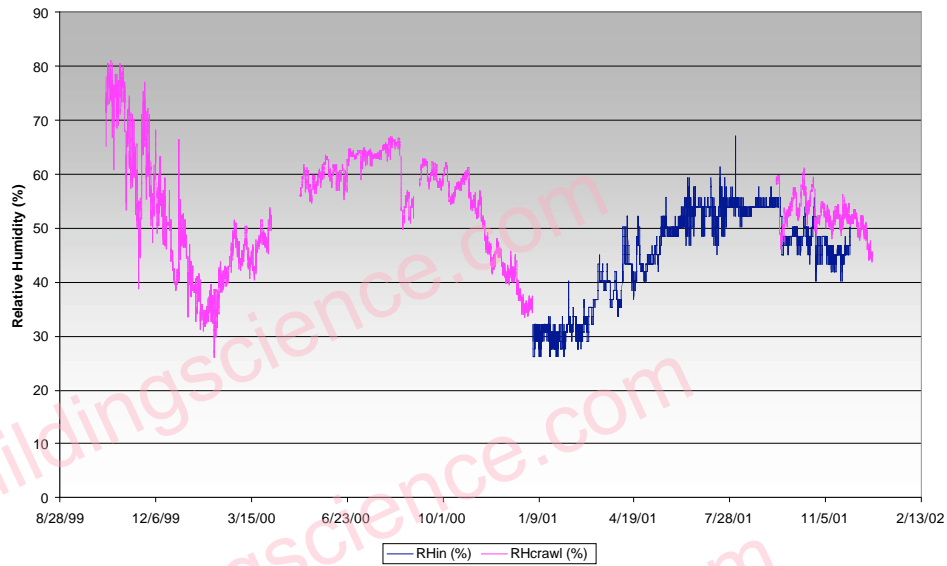

Graph 9: Meeder House (Columbus) Indoor and Crawl Space Relative Humidity

The Albuquerque House plot of crawl space temperature is presented in Graph 10, the Albuquerque House plot of crawl space dew point temperature is presented in Graph 11 and the Albuquerque House plot of crawl space relative humidity is presented in Graph 12. Note how steady, consistent and “flat” the plots are for temperature, dew point and relative humidity. The Albuquerque House crawl space contains an active supply duct providing conditioned air to the crawl space. Transfer grilles provide a return path to the indoor space above the crawl space.

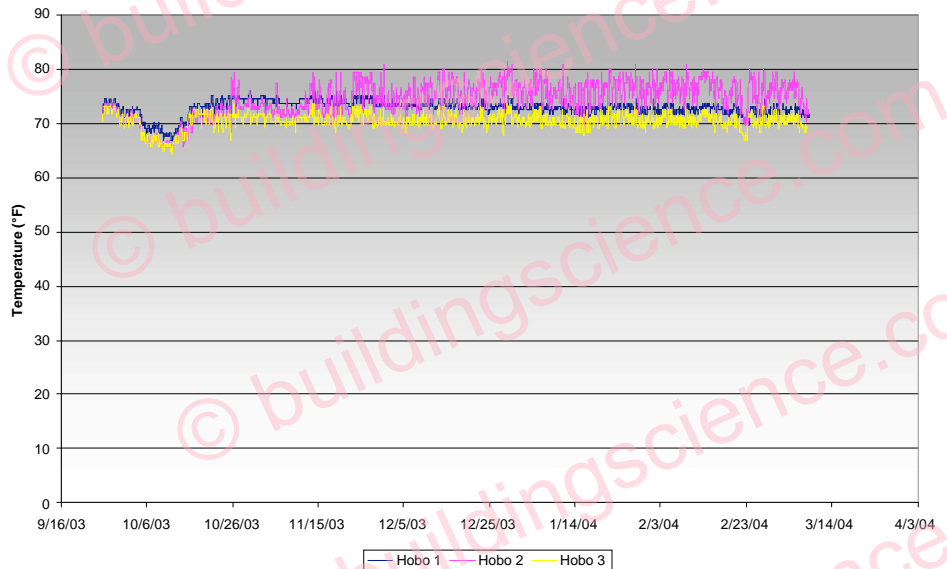

Graph 10: Albuquerque House Crawl Space Temperature

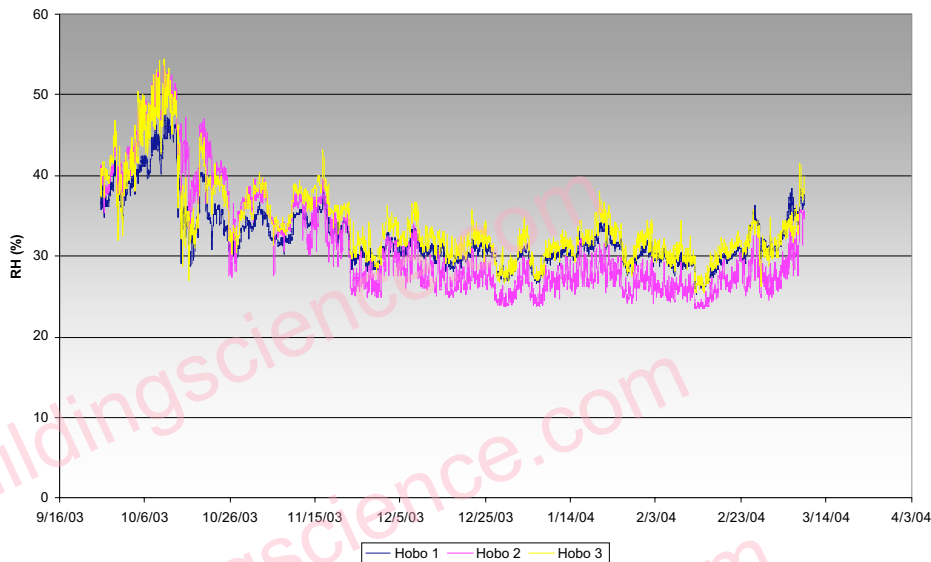

Graph 12: Albuquerque House Crawlspace Relative Humidity

The differences between the crawl spaces that are “actively” conditioned (the Cleveland House, the Meeder House and the Albuquerque House) versus the crawl space that is “passively” conditioned (Gates House) are quite significant. Active conditioning, as can be expected, does a much better job of controlling conditions in the crawl space. As will be noted later, in the Code discussion, the model codes require “active conditioning”. Based on the monitored data, this appears to be a good idea. As can be expected, there will always be situations where “active” conditioning is unnecessary – such as dry climates and where small crawl spaces are well connected to conditioned basement spaces.

Code Language

The 2003 International Mechanical Code (IMC), the 2003 International Building Code (IBC), the 2004 Supplement to the International Energy Conservation Code (IECC) and the 2004 Supplement to the International Residential Code (IRC) are all very explicit regarding crawl spaces, ventilation, ground covers, insulation and conditioning.

Singularly and in combination the model codes require that unventilated crawl spaces (i.e. those without passive crawl space vents connecting the crawl space to the exterior) be constructed with continuous ground covers, have their perimeter walls insulated and the crawl space to be conditioned:

2003 International Mechanical Code

Chapter 4 Ventilation

Section 406 Ventilation of Uninhabited Spaces

406.1 General. Uninhabited spaces, such as crawl spaces and attics, shall be provided with natural ventilation openings as required by the International Building Code or shall be provided with a mechanical exhaust and supply air system. The mechanical exhaust rate shall be not less than 0.02 cfm per square foot (0.00001 m³/s – m²) or horizontal area and shall be automatically controlled to operate when the relative humidity in the space served exceeds 60 percent.

The 2003 IMC tells you that unvented crawls spaces must be provided with a mechanical exhaust and supply air system and sets the rate and the conditions of operation (i.e. a relative humidity limit is set).

2003 International Building Code

Chapter 12 Interior Environment

1203.3 Under-Floor Ventilation.

1203.3.1 Openings For Under-Floor Ventilation.

1203.3.2. *Exceptions. The following are exceptions to Sections 1203.3 and 1203.3.1:*

1. *Where warranted by climatic conditions, ventilation openings to the outdoors are not required if ventilation openings to the interior are provided.*
2. *Ventilation openings are not required where continuously operated mechanical ventilation is provided at a rate of 1.0 cubic foot per minute (cfm) for each 50 square feet (1.02 L/s for each 10 m²) of crawl space floor area and the ground surface is covered with an approved vapor retarder.*
3. *Ventilation openings are not required when the ground surface is covered with an approved vapor retarder, the perimeter walls are insulated and the space is conditioned in accordance with the International Energy Conservation Code.*

2004 Supplement to the IECC

IECC, Section 402, Building Thermal Envelope

402.2.8 Crawl Space Walls. As an alternative to insulating floors over crawl spaces, crawl space walls shall be permitted to be insulated when the crawl space is not vented to the outside. Crawl space wall insulation shall be permanently fastened to the wall and extend downward from the floor to the finished grade level and then vertically and/or horizontally for at least an additional 24 inches (610 mm). Exposed earth in unvented crawl space foundations shall be covered with a continuous vapor retarder. All joints of the vapor retarder shall overlap by 6 inches (153 mm) and be sealed or taped. The edges of the vapor retarder shall extend at least 6 inches (153 mm) up the stem wall and shall be attached to the stem wall.

2004 Supplement To The IRC

IRC, Section R408.3, Unvented Crawl Space

R408.3 Unvented Crawl Space. Ventilation openings in under-floor spaces specified in Sections R408.1 and R408.2 shall not be required where:

1. *Exposed earth is covered with a continuous vapor retarder. All joints of the vapor retarder shall overlap by 6 inches (153 mm) and be sealed or taped. The edges of the vapor retarder shall extend at least 6 inches (153 mm) up the stem wall and shall be attached to the stem wall,*
2. *And one of the following is provided for the under-floor space:*
 - a. *Continuously operated mechanical exhaust ventilation at a rate equal to 1 cfm (0.47 L/s) for each 50 ft² (4.7 m²) of crawl space floor area, including an air pathway to the common area (such as a duct or transfer grille), and perimeter walls insulated in accordance with Section N1102.2.8, or*
 - b. *Conditioned air supply sized to deliver at a rate equal to 1 cfm (0.47 L/s) for each 50 ft² (4.7 m²) of under-floor area, including a return air pathway to the common area (such as a duct or transfer grille), and perimeter walls insulated in accordance with Section N1102.2.8, or*
 - c. *Plenum complying with Section M1601.4, if under-floor space is used as a plenum.*

The 2003 IBC tells you that ventilation openings are not always required based on the climate if ventilation openings to the interior are provided. It goes on to say that ventilation openings are also not required if mechanical ventilation is provided and it tells you how much to provide. Finally, the 2003 IBC says that ventilation openings are not required if a ground cover is provided and the crawl space perimeter is insulated and the crawl space is conditioned in accordance with the IECC.

The 2004 Supplement to the IECC tells you that you do not have to insulate the floor of a crawl space if you insulate the perimeter of the crawl space, it tells you how much insulation to install and it tells you that a ground cover is required. The 2004 Supplement to the IECC also provides the following definition for a conditioned space:

Conditioned Space. An area or room within a building being heated or cooled, containing uninsulated ducts, or with a fixed opening directly into an adjacent conditioned space.

The 2004 Supplement to the IRC tells you that ventilation openings are not necessary if you have a ground cover and if you provide some form of conditioning. It explicitly allows three approaches to conditioning. The first uses the concept of transfer air where air from the living space (which is a conditioned space) is pulled into the crawl space via a duct or transfer grille due to the exhaust action of a fan that pulls air out of the crawl space and exhausts it to the exterior. The size of the fan is also specified. The second uses the concept of supply air and a return air pathway – an approach similar to that of providing conditioning to a bedroom or a basement. The quantity of conditioning air is also specified. The third uses the concept of the crawl space as a supply plenum. In this plenum approach to conditioning additional specific requirements are required and are referenced in Section M1601.4:

2003 International Residential Code
Chapter 16 Duct Systems

M1601.4 Under Floor Plenums. An under-floor space used as a supply plenum shall conform to the requirements of this section. Fuel gas lines and plumbing waste cleanouts shall not be located within the space.

M1601.4.1 General. The space shall be cleaned of loose combustible materials and scrap, and shall be tightly enclosed. The ground surface of the space shall be covered with a moisture barrier having a minimum thickness of 4 mils (0.102 mm).

M1601.4.2 Materials. The under-floor space, including the sidewall insulation, shall be formed by materials having flame-spread ratings not greater than 200 when tested in accordance with ASTM E 84.

M1601.4.3 Furnace Connections. A duct shall extend from the furnace supply outlet to not less than 6 inches (152 mm) below the combustible framing. This duct shall comply with the provisions of Section M1601.1. A noncombustible receptacle shall be installed below any floor opening into the plenum in accordance with the following requirements:

- 1. The receptacle shall be securely suspended from the floor members and shall not be more than 18 inches (457 mm) below the floor opening.*
- 2. The area of the receptacle shall extend 3 inches (76 mm) beyond the opening on all sides.*
- 3. The perimeter of the receptacle shall have a vertical lip of at least 1 inch (25.4 mm) high at the open sides.*

M1601.4.4 Access. Access to an under-floor plenum shall be provided through an opening in the floor with minimum dimensions of 18 inches by 24 inches (457 mm by 610 mm).

M1601.4.5 Furnace Controls. The furnace shall be equipped with an automatic control that will start the air-circulating fan when the air in the furnace bonnet reaches a temperature not greater than 150 degrees F (66 degrees C). The furnace shall additionally be equipped with an approved automatic control that limits the outlet air temperature to 200 degrees F (93 degrees C).

This section is also quite specific. It only applies when the crawl space is used as a plenum. In other words when using R408.3, 2, (c) not when using R408.3.2, (a) or R408.3.2 (b). Many builders and many building code officials erroneously interpret the code to require that the provisions of Section M1601.4 apply to all conditioned crawl spaces and not just to crawl spaces that are used as supply plenums.

A plenum is defined in the 2003 IRC as:

Plenum. A chamber that forms part of an air-circulation system other than the occupied space being conditioned.

A conditioned crawl space is by definition the space that is being conditioned when air is supplied to it via a supply duct or via a transfer grille or opening. It is therefore not a plenum. A crawl space is only a plenum when the crawl space is supplying air to the space above (or adjacent to it) for the purpose of conditioning the space above (or adjacent to it).

The issue is some what muddled when it is argued that the requirements do not apply to crawl spaces if it is interpreted that a crawl space is not an “occupied space”. If the crawl space is considered a utility space or storage

space or simply a conditioned space and these types of spaces are also considered “occupied space” then the issue is moot. The 2003 IRC is not helpful as it defines occupied space as follows:

Occupied Space. The total area of all buildings or structures on any lot or parcel of ground projected on a horizontal plane, excluding permitted projections as allowed by this code.

This definition was clearly not intended to apply to this particular issue although if this language is strictly and literally interpreted the matter once again becomes moot as under this definition a crawl space is “occupied space” regardless of whether it is vented or not, conditioned or not.

The 2003 International Mechanical Code (IMC) defines a plenum as follows:

Plenum. An enclosed portion of the building structure, other than an occupiable space being conditioned, that is designed to allow air movement, and thereby serve as part of an air distribution system.

This is somewhat different than the definition in the 2003 IRC. The term occupiable space is used rather than occupied space. The 2003 IMC does not define occupiable space. For the definition of occupiable space we have to go to the 2003 IBC:

Occupiable Space. A room or an enclosed space designed for human occupancy in which individuals congregate for amusement, educational or similar purposes or in which occupants are engaged at labor, and which is equipped with a means of egress and light and ventilation facilities meeting the requirements of this code.

Under this definition, a conditioned crawl space clearly does not meet the definition of occupiable space. Also, equally clearly, the issue of conditioned crawl spaces was not considered when this particular definition was established. Although you could argue that sometimes people go into crawl spaces for amusement or education purposes – and we do typically provide light in a conditioned crawl space (a light bulb and switch) and ventilation via provisions for supplying and returning or exhausting air and therefore a conditioned crawl space is an occupiable space. Of course, this type of argument is ridiculous in the extreme and is as weak as the argument used by some individuals to include conditioned crawl spaces in the definition of plenums since the existing plenum definitions contain references to occupied space or occupiable space.

The 2004 Supplement to the IRC clearly intended to treat conditioned crawl spaces differently than crawl spaces that are designed to be used as plenums since a separate requirement/provision was provided for crawl spaces used as plenums in the code language. The definitions section of the code needs to be cleared up to make this explicitly clear. Until this happens there will continue to be individuals using the occupiable space definition as a club to require the provisions of Section M1601.4 to apply to all conditioned crawl spaces.

An extremely simple way to clear up the confusion is to alter the definition of a plenum by deleting the word “occupied” from the existing definition in the 2003 IRC. The new definition would read as follows:

Plenum. A chamber that forms part of an air-circulation system other than the space being conditioned.

In the 2003 IMC the definition of plenum should also be altered by deleting the words “an occupiable” and replacing them with the word “the” so that the new definition would read as follows:

Plenum. An enclosed portion of the building structure, other than the space being conditioned, that is designed to allow air movement, and thereby serve as part of an air distribution system.

Alternatively, a definition of “occupiable space” could be provided for the 2003 IRC and the word “occupied” in the definition of “plenum” be changed to “occupiable”. The definition of “occupiable space” for the 2003 IRC could read as follows:

Occupiable Space: Any room or enclosed space intended for human activities, including but not limited to, all bedrooms, kitchens, dining rooms, bathrooms, toilets, closets, halls, storage and utility areas, laundry areas and conditioned crawl spaces and conditioned attic spaces.

The bottom line is that crawl space ventilation is not required by the model codes if:

- a ground cover is provided
- the perimeter walls are insulated
- the crawl space is conditioned

Based on the field testing and experience, these are good requirements. However, the issue of plenum definition still needs to be clarified so that the explicit language of the model codes meets the obvious intent of the model codes regarding conditioned crawl spaces.

About this Report

This report was prepared for the US Department of Energy's Building America Program (see Building America cover page for more information). The report is freely available to the public at www.buildingamerica.gov.

About the Author

Joseph Lstiburek, Ph.D., P.Eng., is a principal of Building Science Corporation in Westford, Massachusetts. He has twenty-five years of experience in design, construction, investigation, and building science research. Joe is an ASHRAE Fellow and an internationally recognized authority on indoor air quality, moisture, and condensation in buildings. More information about Joseph Lstiburek can be found at www.buildingsciencecorp.com

Direct all correspondence to: Joseph Lstiburek, Building Science Corporation, 70 Main Street, Westford, MA 01886

Limits of Liability and Disclaimer of Warranty:

Building Science documents are intended for professionals. The author and the publisher of this article have used their best efforts to provide accurate and authoritative information in regard to the subject matter covered. The author and publisher make no warranty of any kind, expressed or implied, with regard to the information contained in this article.

The information presented in this article must be used with care by professionals who understand the implications of what they are doing. If professional advice or other expert assistance is required, the services of a competent professional shall be sought. The author and publisher shall not be liable in the event of incidental or consequential damages in connection with, or arising from, the use of the information contained within this Building Science document.